

# TRANSFORMERS

## DARK OF THE MOON™

**AUTOBOT™** ADVANCED  
**BUMBLEBEE™** LEVEL: 1 2 3



**WARNING:**  
CHOKING HAZARD—Small parts.  
Not for children under 3 years.

**AGES 5+**  
28747/28745 ASST.

**x2**  
1.5V AA or R6 size  
**BATTERIES INCLUDED**

Replace with 2 x 1.5V "AA" or R6 size batteries. Alkaline batteries recommended. Phillips/cross head screwdriver (not included) needed to replace batteries.

NOTE: Some parts are made to detach if excessive force is applied, and are designed to be reattached if separation occurs. Adult supervision may be necessary for younger children.

### CHANGING TO VEHICLE

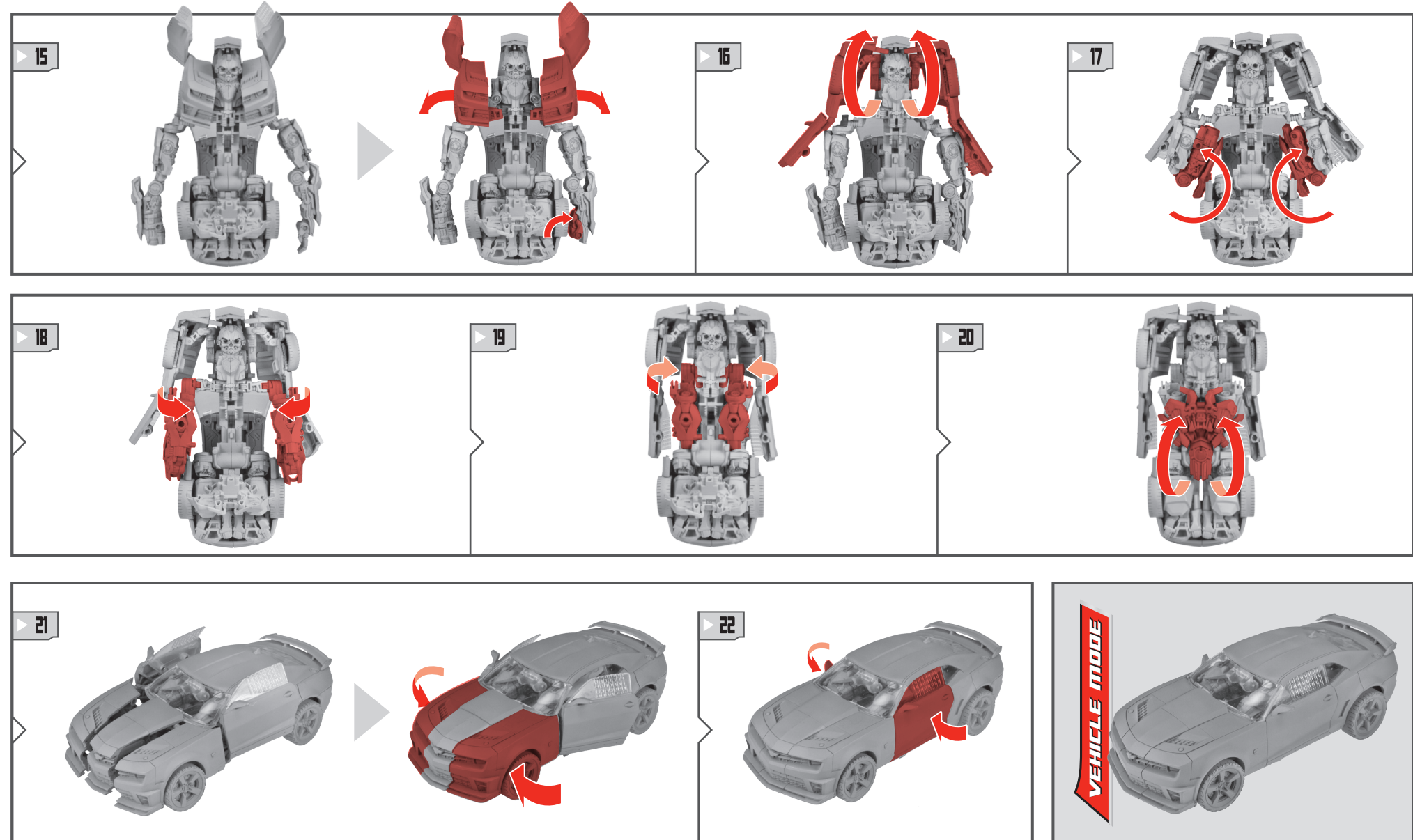
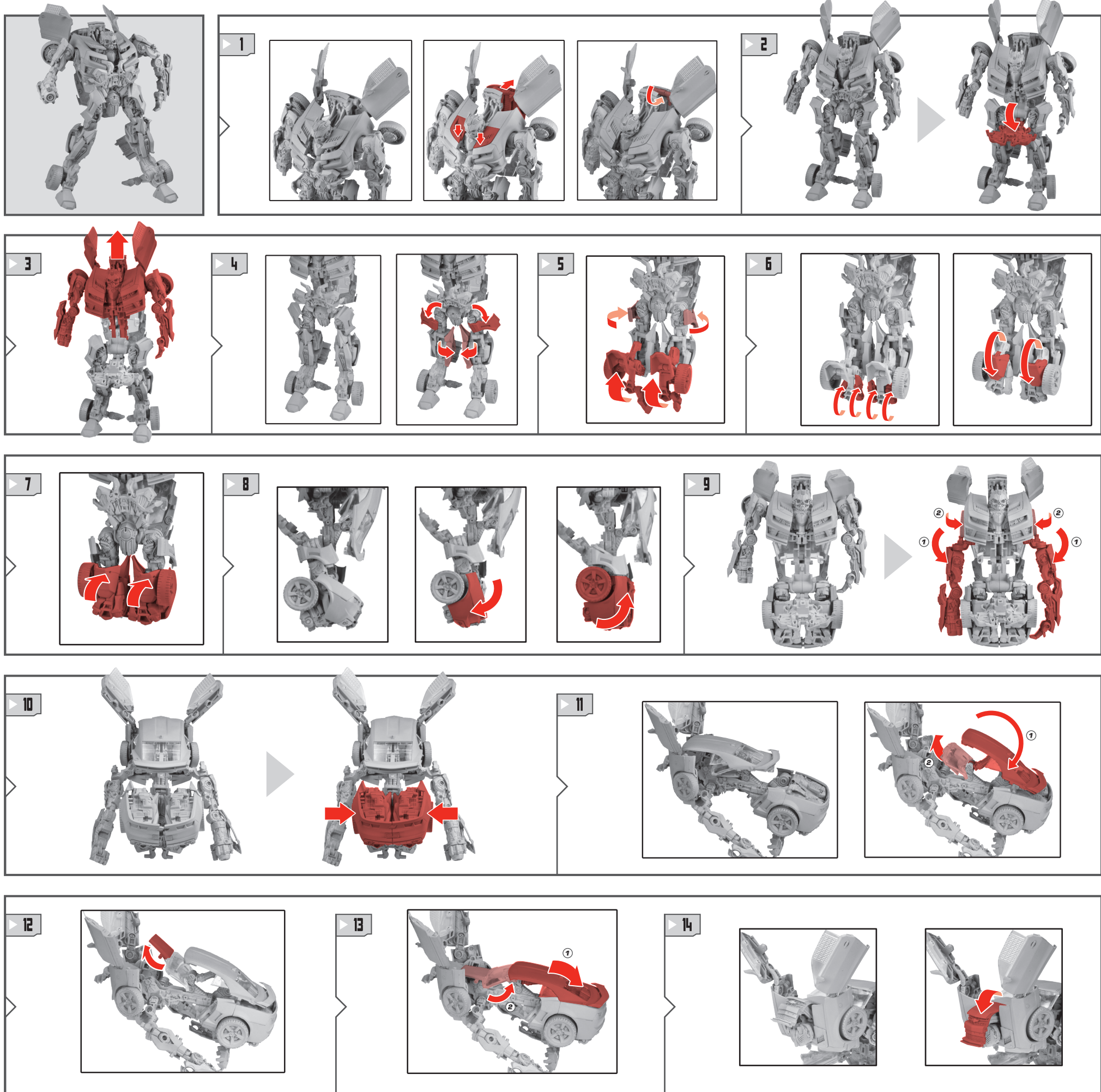

#### TO REPLACE BATTERIES:

Use a Phillips/cross head screwdriver (not included) to loosen screw in battery compartment door. Remove door and discard old batteries. Insert 2 x 1.5V "AA" or R6 size batteries. Alkaline batteries recommended. Replace door and tighten screw.

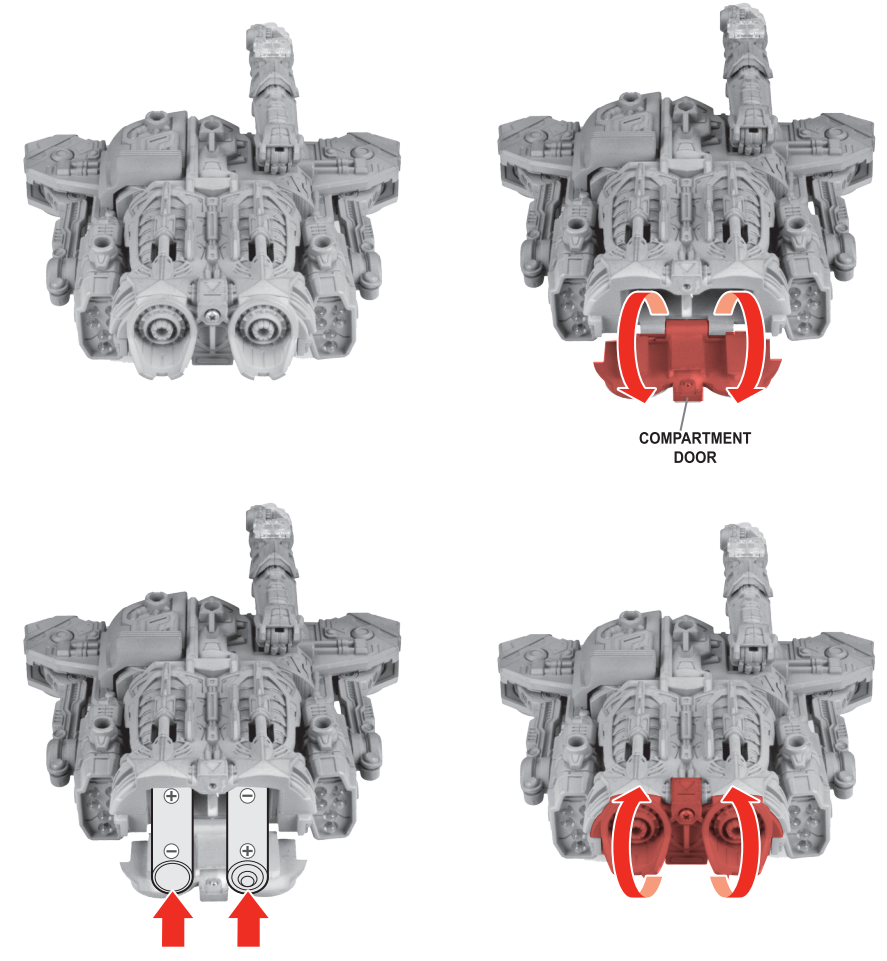

#### IMPORTANT: BATTERY INFORMATION

##### CAUTION:

- Always follow the instructions carefully. Use only batteries specified and be sure to insert them correctly by matching the + and - polarity markings.
- Do not mix old batteries and new batteries or standard (carbon-zinc) with alkaline batteries.
- Remove exhausted or dead batteries from the product.
- Remove batteries if product is not to be played with for a long time.
- Do not short-circuit the supply terminals.
- Should this product cause, or be affected by, local electrical interference, move it away from other electrical equipment. Reset (switching off and back on again or removing and re-inserting batteries) if necessary.
- RECHARGEABLE BATTERIES:** Do not mix these with any other types of batteries. Always remove from the product before recharging. Recharge batteries under adult supervision. **DO NOT RECHARGE OTHER TYPES OF BATTERIES.**

#### FCC STATEMENT

This device complies with part 15 of the FCC Rules. Operation is subject to the following two conditions: (1) This device may not cause harmful interference, and (2) this device must accept any interference received, including interference that may cause undesired operation. This equipment has been tested and found to comply with the limits for a Class B digital device, pursuant to part 15 of the FCC Rules. These limits are designed to provide reasonable protection against harmful interference in a residential installation. This equipment generates, uses and can radiate radio frequency energy, and, if not installed and used in accordance with the instructions, may cause harmful interference to radio communications. However, there is no guarantee that interference will not occur in a particular installation. If this equipment does cause harmful interference to radio or television reception, which can be determined by turning the equipment off and on, the user is encouraged to try to correct the interference by one or more of the following measures:

- Reorient or relocate the receiving antenna.
- Increase the separation between the equipment and receiver.
- Consult the dealer or an experienced radio/TV technician for help.

CAUTION: Changes or modifications to this unit not expressly approved by the party responsible for compliance could void the user's authority to operate the equipment.

CHANGING TO ROBOT

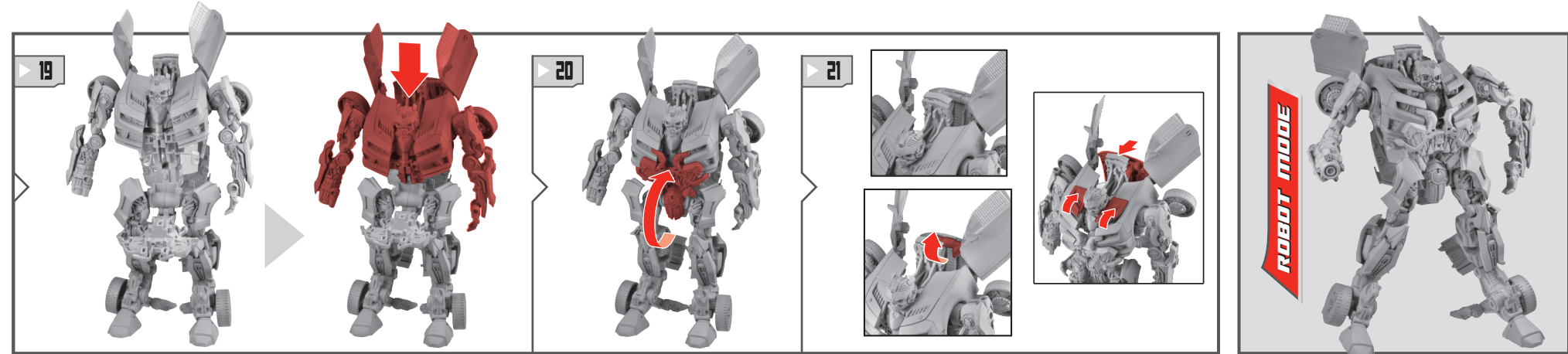
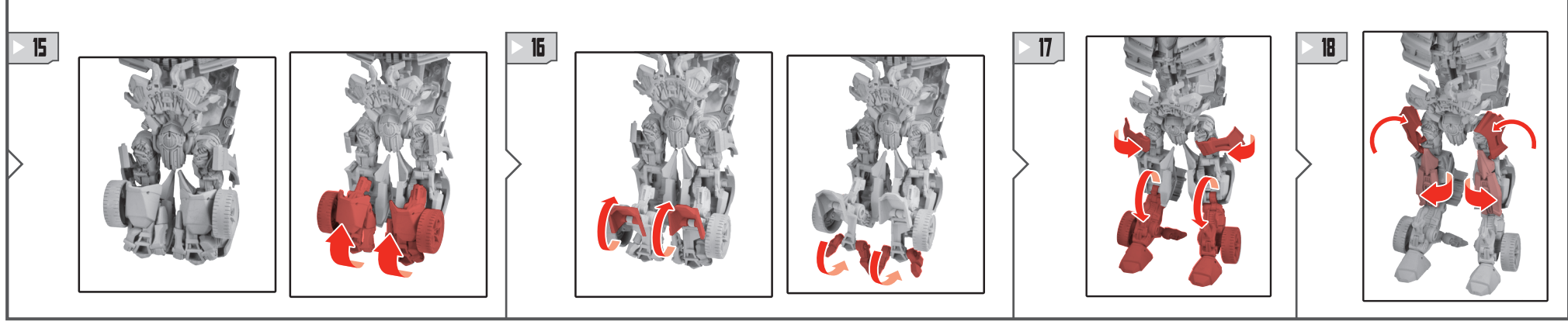
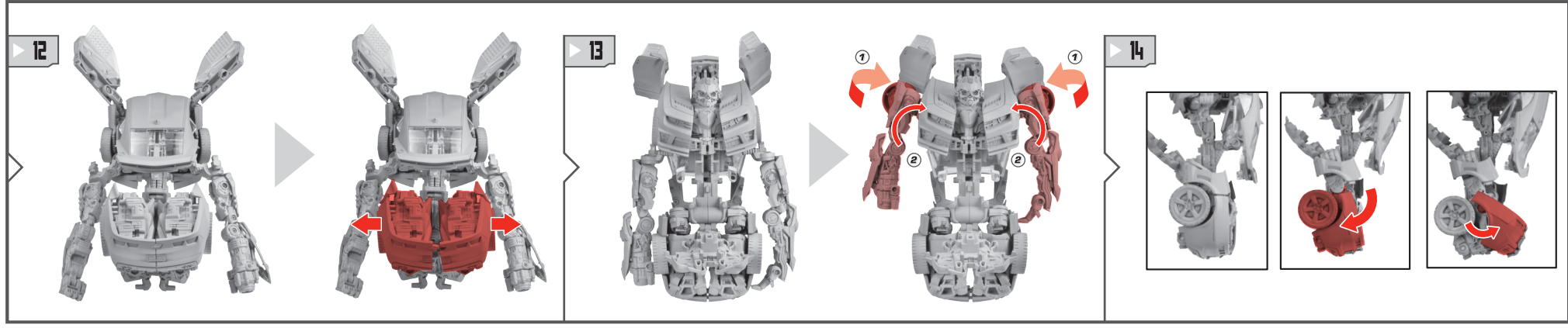
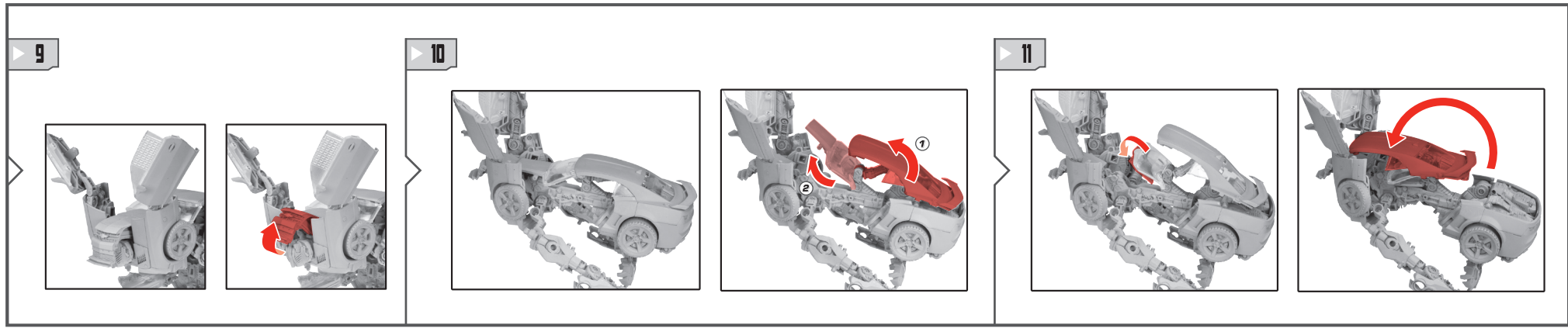
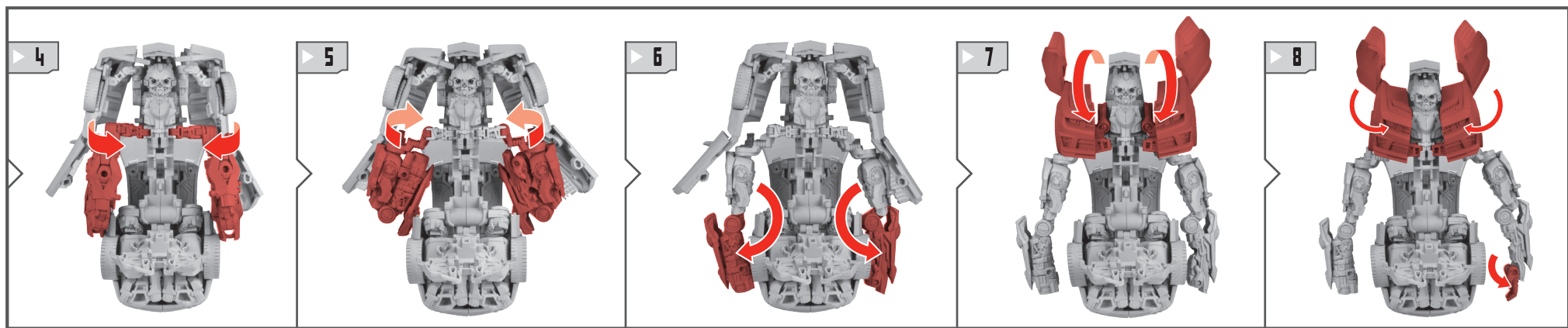
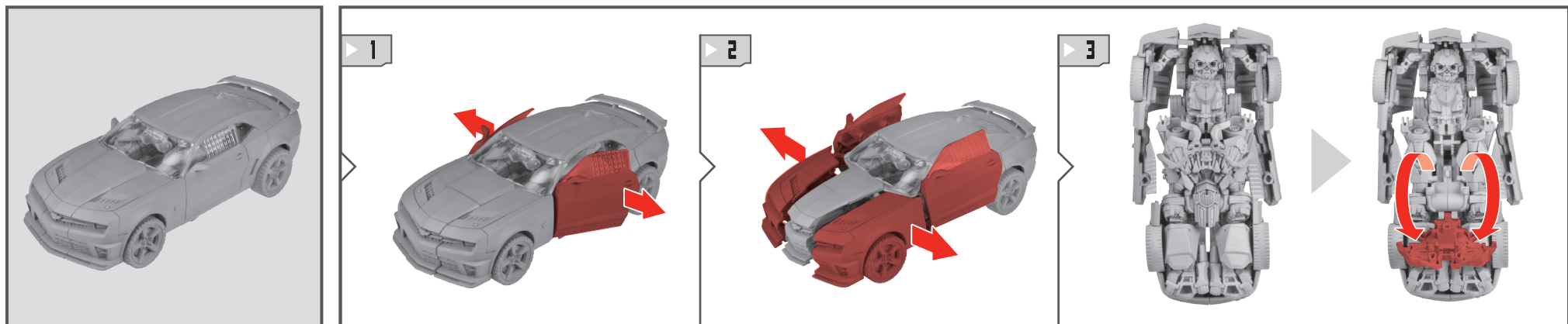

ROBOT MODE

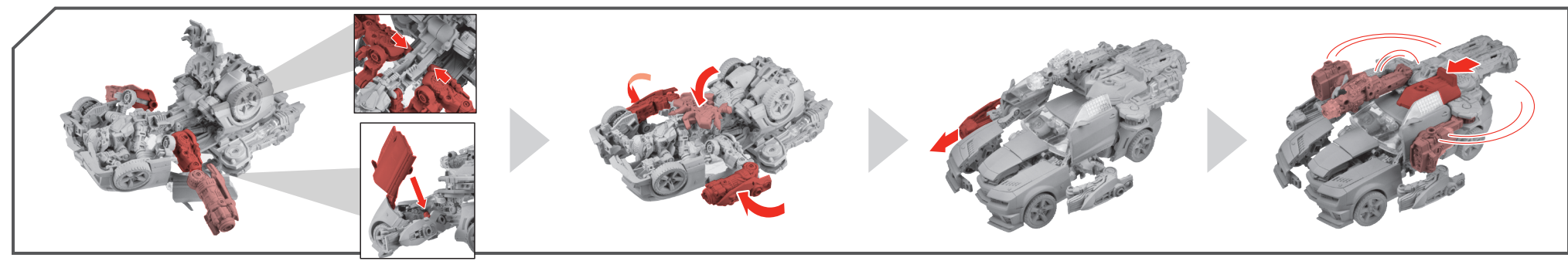
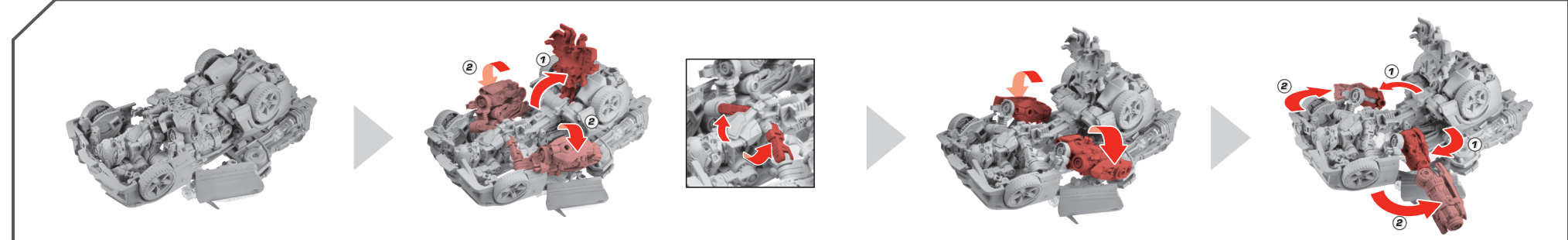
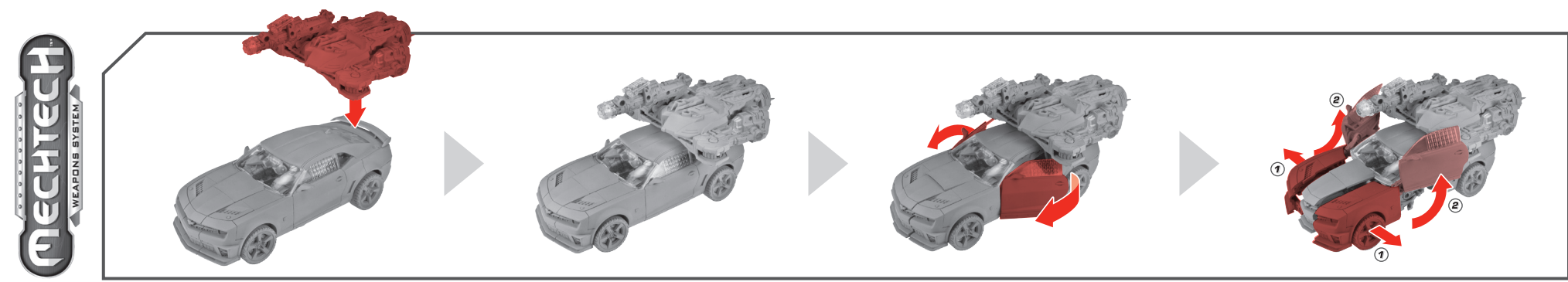
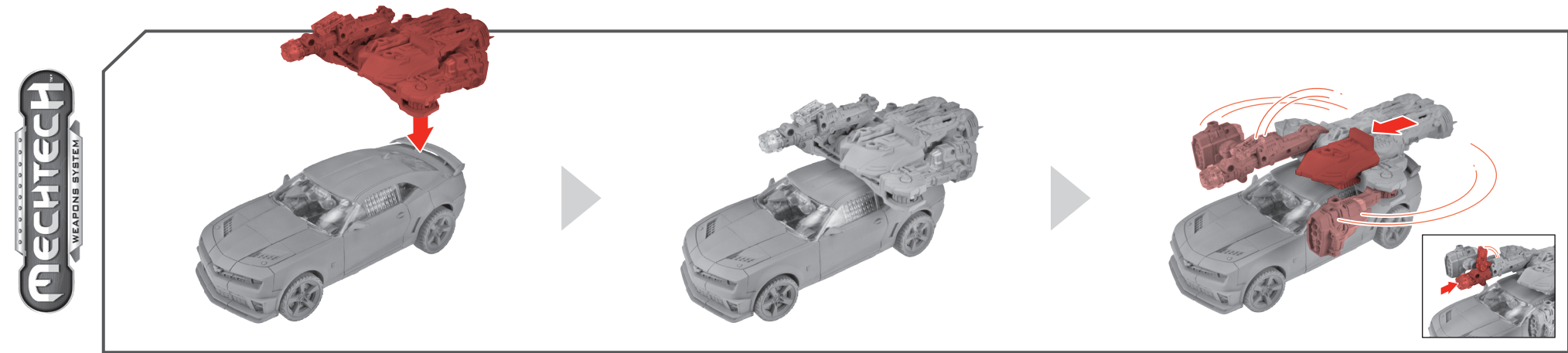
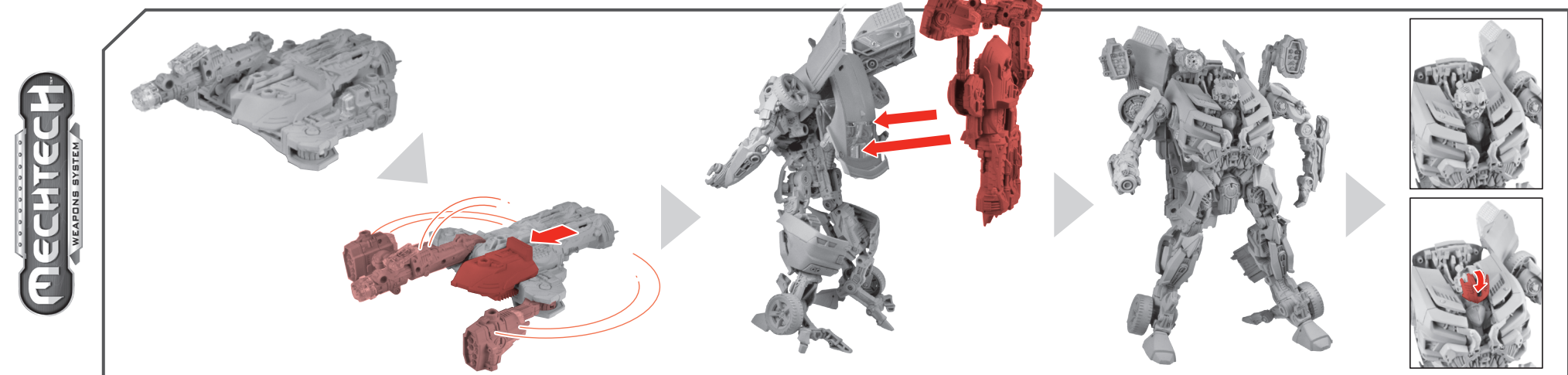

Retain instructions for future reference.

Product and colors may vary. Some poses may require hand support.

© 2010 Paramount Pictures Corporation. Manufactured under license from TOMY Company, Ltd. ® and/or TM® & © 2010 Hasbro. All Rights Reserved. TM & © denote U.S. Trademarks.



Camaro and all related Emblems and body designs are General Motors Trademarks used under license to Hasbro, Inc.

P/N 7135760000

TRANSFORMERS.COM/INSTRUCTIONS

# TRANSFORMERS

DARK OF THE MOON™

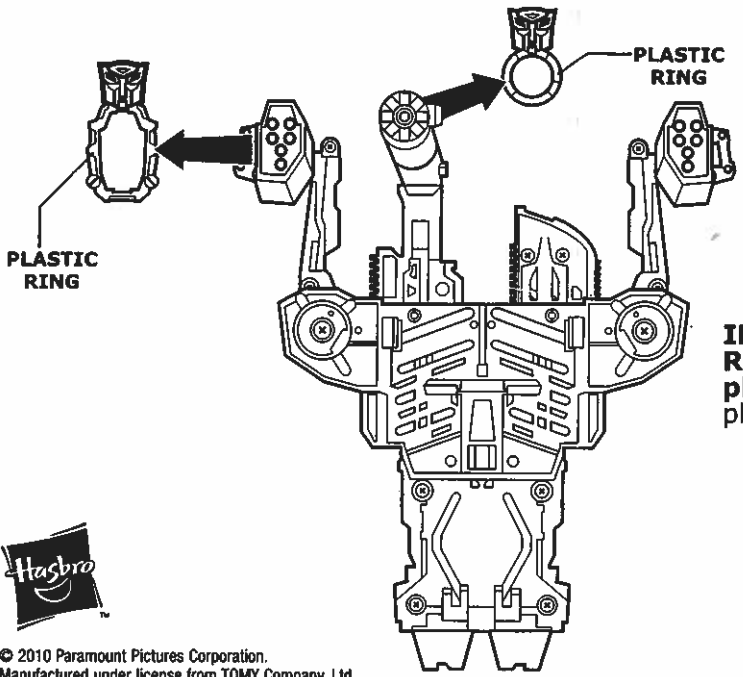

**⚠ WARNING:**  
CHOKING HAZARD—Small parts.  
Not for children under 3 years.

**IMPORTANT!**  
Remove and discard  
plastic rings before first  
playing with the toy.



© 2010 Paramount Pictures Corporation.  
Manufactured under license from TOMY Company, Ltd.  
© 2010 Hasbro. All Rights Reserved. TM & ® denote U.S. Trademarks.

[TRANSFORMERS.COM/INSTRUCTIONS](http://TRANSFORMERS.COM/INSTRUCTIONS)

P/N 7135770000